

OpenAir® Electric Damper Actuators

GDE/GLB Series

Non-spring Return Rotary

24 Vac - Modulating Control 0 to 10 Vdc



Description The OpenAir direct coupled 24 Vac non-spring return rotary electric actuators are designed for modulating control of dampers.

- Features**
- Compact, lightweight design
 - Self-adapting capability for maximum flexibility in damper positioning
 - Manual override
 - Offset and slope adjustment models available
 - Independently adjustable dual auxiliary switches available
 - cUL and UL listed; CE certified

Application These actuators are used in constant or variable air volume installations for control of HVAC dampers requiring up to 44 lb-in (5 Nm) or 88 lb-in (10 Nm) of torque.

Product Numbers

Table 1.

Torque	Standard	Slope/ Offset Adjustable	Dual Auxiliary Switches and Slope/Offset Adjustable	Dual Auxiliary Switches Only	Pre-Cabled	No Cables
44 lb-in (5 Nm)	GDE161.1P	GDE163.1P	GDE164.1P	GDE166.1P	Plenum	—
	GDE161.1P/B (24 pk)			—	—	
	GDE161.1Q	—	—	—	6 ft length	—
	GDE161.1N	—	—	—	—	Post Header AMP
	GDE161.1N/B (24 pk)	—	—	—	—	
	GDE161.1T	—	—	—	—	Terminal Strip
	GDE161.1T/B (24 pk)	—	—	—	—	
88 lb-in (10 Nm)	GLB161.1P	GLB163.1P	GLB164.1P	GLB166.1P	Plenum	—
	GLB161.1Q	—	—	—	6 ft length	—

Specifications	Operating voltage (G–G0)	24 Vac +20%, -15%
	Frequency	50/60 Hz
Power Supply	Power consumption	3.3 VA
	Input signal (Y-G0)	
Control signal	Voltage-input	0 to 10 Vdc Input resistance >100K ohms
	Position output signal (GDE161.1T and GDE161.1N do not have feedback signals)	(U–G0)
Feedback signal	Voltage-output	0 to 10 Vdc Maximum output current DC 1 mA
	Rating	Class 2 according to UL, CSA Class III per EN60730
Auxiliary features	Control signal adjustment	
	Offset (start point)	Between 0 to 5 Vdc
	Slope (span)	Between 2 and 30 Vdc
	Dual auxiliary switch contact rating	4A resistive, 2A inductive
	Voltage	24 Vac/24 Vdc
	DC rating	12 to 30 Vdc DC 2A
	Switch Range	
	Switch A	0 to 90° with 5° intervals
	Recommended range usage	0 to 45°
	Factory setting	5°
	Switch B	0 to 90° with 5° intervals
	Recommended range usage	45° to 90°
	Factory setting	85°
Switching hysteresis:	2°	
Function	Torque	
	GDE	44 lb-in (5 Nm)
	GLB	88 lb-in (10 Nm)
	Runtime for 90° opening or closing	
	GDE	90 sec. at 60 Hz (108 sec. at 50 Hz)
	GLB	125 sec. at 60 Hz (150 sec. at 50 Hz)
	Nominal angle of rotation	90°
Maximum angular rotation	95°	
Mounting	Shaft size: Minimum shaft length 3/4-inch (20 mm)	

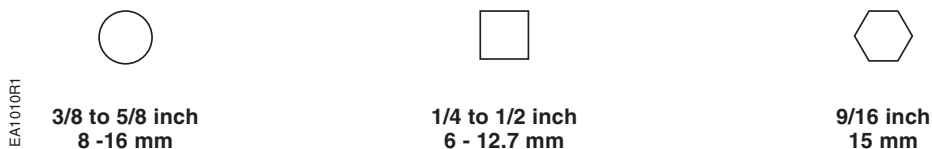

Figure 1. Acceptable Shaft Sizes.

Specifications, continued

Housing	Enclosure	NEMA Type 2 IP54 according to EN60529
	GDE161.1T and GDE161.1N	NEMA 1
	Material	Durable plastic
	Gear lubrication	Silicone-free
Ambient conditions	Ambient temperature	
	Operation	-25°F to 130°F (-32°C to 55°C)
	Storage and transport	-40°F to 158°F (-40°C to 70°C)
	Ambient humidity (non-condensing)	95% rh
Agency certification		UL listed to UL873
		cUL certified to Canadian Standard C22.2 No. 24-93
	These devices were approved for installation in plenum areas by Underwriters Laboratories, Inc., per UL 1995.	
CE conformity	In accordance with the directive set forth by the European Union for	
	Electromagnetic Compatibility (EMC)	2004/108/EC
	Emissions standards	EN61000-6-3
	Immunity standards	EN61000-6-2
Miscellaneous	Pre-cabled connection	18 AWG
	Standard cable length	3 ft (0.9 m)
	Life cycle	Designed for over 60,000 full strokes and a minimum of 1.5 million repositions at rated torque and temperature
	Dimensions inches (mm)	6.2 L x 2.8 W x 2.4 D (157 L x 71 W x 61 D)
	Weight:	1.06 lb (0.48 kg)
	Country of Origin	USA

Accessories

NOTE: The auxiliary switches cannot be added in the field. Order the product number that includes this option. See Table 1.

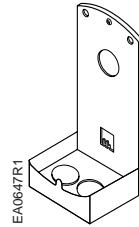

Figure 2. Conduit Adapter.

ASK76.1U: Provides connection between the actuator and conduit.

NOTE: GDE161.1T Terminal Strip and GDE161.1N Post Header AMP are not compatible with the ASK76.1U.

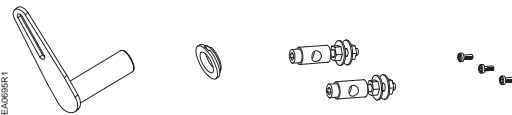

Figure 3. Rotary to Linear.

ASK71.5: Allows a direct-coupled actuator to provide an auxiliary linear drive.

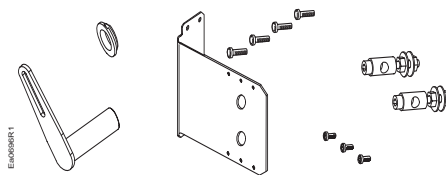

Figure 4. Rotary to Linear with Bracket.

ASK71.6: Allows economical mounting of an OpenAir actuator to a variety of surfaces.

Should be used in applications where the actuator can be rigid-surface mounted and a linear stroke output is needed.

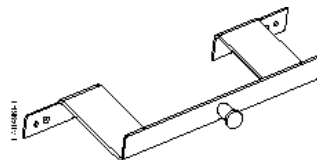

Figure 5. Tandem Mount Bracket.

ASK73.1: Bracket provides extended anti-rotation pin allowing two OpenAir actuators to directly drive a single damper shaft. For use with two- and three-position actuators.

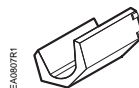

Figure 6. Shaft Insert.

ASK78.3U: Shaft inserts for use with 3/8-inch (8 to 10 mm) diameter shafts. (10/pk). Included in box with GDE/GLB Series.

NOTE: Factory-installed 1/2-inch guide must be removed prior to installation.

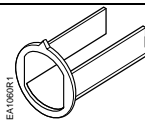

Figure 7. 1/2-inch Shaft Guide.

985-101P25: Shaft guide, 1/2-inch (25/pk). Factory installed with GDE/GLB Series.

Accessories, Continued



Figure 8.

985-133: 0 to 10 Vdc input cable
 3 ft, 12 pk



Figure 9.

985-134: Daisy chain cable 12 ft, 12 pk
985-135: Daisy chain cable 25 ft, 12 pk

Actuator Components

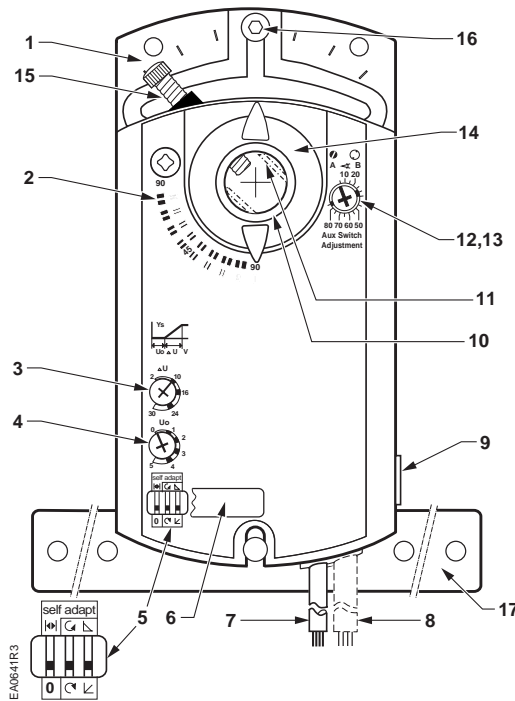

Figure 10. Parts of the Actuator.

Legend

1. Base plate
2. Positioning scale for angle of rotation
3. Slope adjustment
4. Offset (start point) adjustment
5. DIP switches
6. Cover for DIP switches
7. Connection cables
8. Connection cables
9. Manual override
10. Coupling bushing
11. Factory installed 1/2-inch guide
12. Auxiliary switch A
13. Auxiliary switch B
14. Position indicator
15. Adjustment lever with locking screw (4 mm hex)
16. Set screw for mechanical range stop (4 mm hex)
17. Mounting bracket

**Actuator
 Components, Continued**

Terminal Strip

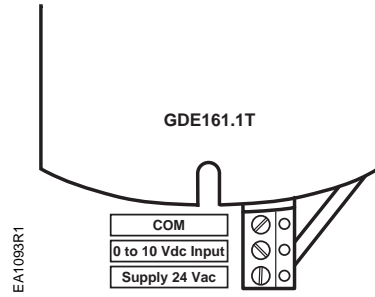

GDE161.1T: The GDE161.1T uses a Terminal Strip for connection purposes rather than cable connections.

Figure 11.

**Post Header
 AMP**

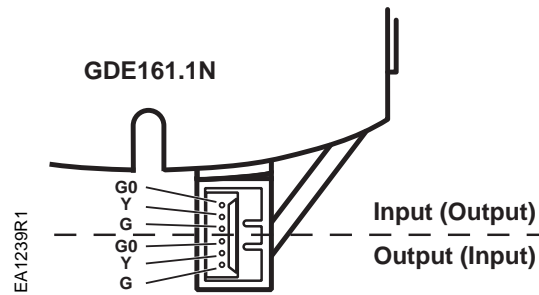

GDE161.1N: The GDE161.1N model uses a Post Header for connection purposes rather than cable connections. The Post Header AMP has two identical sets of contacts.

NOTE: Cables are purchased separately. See *Accessories*.

Figure 12.

Operation

A continuous 0 to 10 Vdc signal from a controller to wire 8 (Y) operates the damper actuator. The angle of rotation is proportional to the control signal. A 0 to 10 Vdc position feedback output signal is available between wire 9 (U) and wire 2 (G0) to monitor the position of the damper motor.

In the event of a power failure, the actuator holds its position. In the event that only the control signal is lost, the actuator returns to the "0" position.

Life expectancy

An improperly tuned loop will cause excessive repositioning that will shorten the life of the actuator.

Control signal adjustment

GDE/GLB163.1P and GDE/GLB164.1P: For sequencing and the electronic limitation of the angle of rotation.

Use the U_o potentiometer to set the offset (start point) between 0 to 5 Vdc.
Use the ΔU potentiometer to set the slope (span) between 2 to 30 Vdc.

NOTE: The Y input is limited to a maximum of 10 Vdc. If the sum of the offset and slope setting is greater than 10V, the angle of rotation is reduced providing the feature of electronic limitation of the angle of rotation.

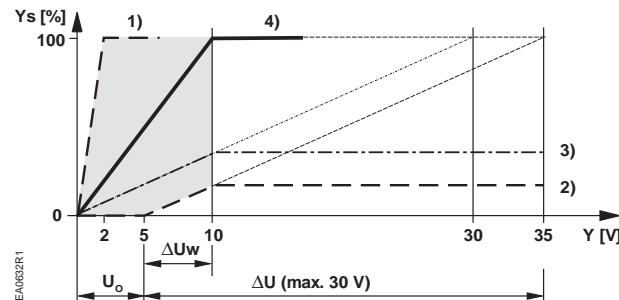
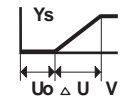

Figure 13.

Y_s Actuator position (100% = angle of rotation 90°*)
 Y Control input signal
 U_o Offset (start point)
 ΔU Slope
 ΔU_w Active voltage range (Y_s changes)

* When the mechanical limitation of the angle of rotation and self-adapt function are ON, 100% does not equal 90°.



SLOPE, ΔU

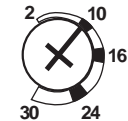

OFFSET, U_o

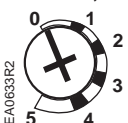

Setting for
10V slope
0 Vdc offset

Figure 14.

Table 2.

Examples in Figure 13	U_o Offset Vdc	ΔU Slope Vdc	Active Voltage Range Vdc	Y_s Actuator Position
1. Minimum slope	0	2	0 to 2	0 to 100%
2. Limitation of rotation	5	30	5 to 10	0 to 16.7%
3. Limitation of rotation	0	30	0 to 10	0 to 33.3%
4. Setting shown in Figure 14	0	10	0 to 10	0 to 100%

Operation, continued

Determine the setting needed to electronically limit the angle of rotation between 0 to 50% (0 to 45°) using a 2 to 10 Vdc input.

Control signal adjustment example:

Calculating the value of ΔU :

$$\Delta U = \frac{100[\%]}{\text{working angle of rotation } Y_s [\%]} \times (10[Vdc] - U_o[Vdc]) = \frac{100\%}{50\%} \times (10Vdc - 2Vdc) = 16Vdc$$

Settings: $U_o = 2 Vdc$;
 $\Delta U = 16 Vdc$

Electronic limitation angle of rotation $Y_s = 50\% (45^\circ)$
 Slope $\Delta U = 16V$
 Active voltage range $\Delta U_w = 2 \text{ to } 10 Vdc$

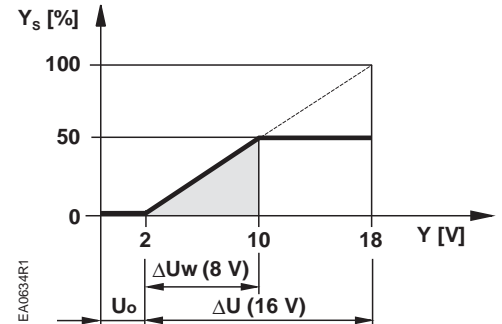

Figure 15. Example.

Auxiliary Switches GDE/GLB164.1P and GDE/GLB166.1P

Figure 16 shows the adjustable switching values for auxiliary switches A and B.

Actuator Scale:
 Clockwise
 Adjustment range for Switches A and B
 Setting interval: 5°
 Switching hysteresis: 2°

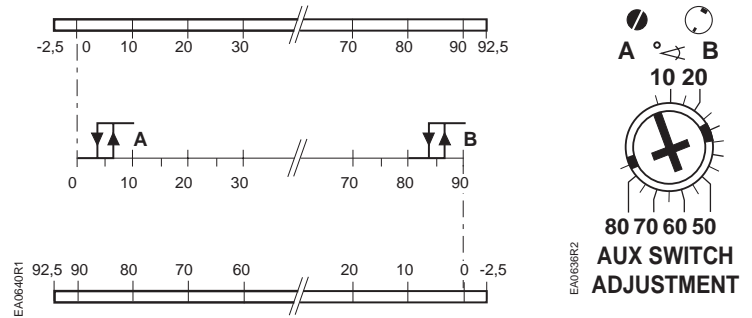

Figure 16. Adjustable Switching Values for the Dual Auxiliary Switches.

NOTE: The auxiliary switch setting shafts rotate with the actuator. The scale is valid only when the actuator is in the "0" position on clockwise motion.

Use the long arm of the † (AUX SWITCH ADJUSTMENT) to point to the position of switch A. Use the narrower tab on the red ring to point to the position of switch B.

**Dual in-Line Package
 (DIP) Switches
 GDE16x.1P
 GLB16x.1P**

Raise the protective cover from left to right to locate the DIP switches. See Figure 10 for the location of the cover.

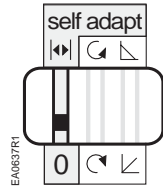

**Figure 17.
 Self-adapt
 Switch.**

The factory setting is 0 (OFF).

When mechanical angle of rotation is limited, the self-adapt switch may be turned ON  so that the limited range will become the new 0 to 100% for the actuator logic. In this case, 0 to 100% is not equal to 90°



CAUTION:

When turning the self-adaptive feature on or after the software reset with the feature on, the actuator will enter a five-minute calibration cycle as the actuator adjusts to the rotation limits of the system. A software reset happens after power on or may be caused by electrostatic discharge (ESD) at levels of 2kV and above.

The position output signal U is not influenced by the self-adapt function. The 0 to 10V feedback signal U is always proportional to 0° to 90° (or 90° to 0°).

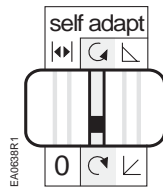

**Figure 18.
 Direction of
 Rotation Switch.**

The factory setting is clockwise.

The direction of rotation switch should match the damper rotation movement.

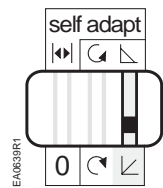

**Figure 19.
 Output Signal
 Switch.**

The factory setting is direct acting.

As the clockwise angle of rotation increases, the output voltage increases.

If the direction of rotation is counterclockwise, the output signal switch should be set at reverse acting to match the direction of the rotation switch.

Sizing

The type of actuator required depends on several factors.

1. Obtain damper torque ratings (ft-lb/ft² or Nm/m²) from the damper manufacturer.
2. Determine the area of the damper.
3. Calculate the total torque required to move the damper:

$$\text{Total Torque} = \frac{\text{Torque Rating} \times \text{Damper Area}}{\text{SF}^1}$$

¹Safety Factor: When determining the torque of an actuator required, a safety factor should be included for unaccountable variables such as slight misalignments, aging of the damper, etc. A suggested safety factor is 0.80 (or 80% of the rated torque).

4. Select the actuator type from Table 3.

Table 3.

Total Torque	Actuator
<44 lb-in (5 Nm)	GDE16x
<88 lb-in (10 Nm)	GLB16x
<132 lb-in (15 Nm)	GEB16x
<221 lb-in (25 Nm)	GBB16x
<310 lb-in (35 Nm)	GIB16x
>310 lb-in >620 lb-in (35 Nm – 70 Nm)	Use tandem mounting bracket ASK73.1 with any GIB1x actuator.

Mounting and Installation

- Place the actuator on the damper shaft so that the front of the actuator is accessible. The label is on the front side. A mounting bracket is included with the actuator.
- The minimum damper drive shaft length is 3/4-inch (20 mm).
- Observe the service envelope around the actuator as shown in Figure 31.
- Detailed mounting instructions are included with each actuator.

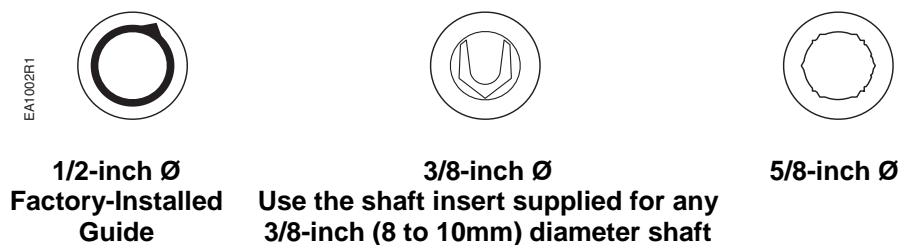

Figure 20. Damper Shaft Sizes.

NOTE: For all damper shafts with the exception of the 1/2-inch round shaft: Remove 1/2-inch Ø guide before installation.

Manual Override

To move the damper blades and lock the position with no power present:

1. Slide the red manual override knob toward the back of the actuator.
2. Make adjustments to the damper position.
3. Slide the red manual override knob toward the front of the actuator.

Once power is restored, the actuator returns to automated control.

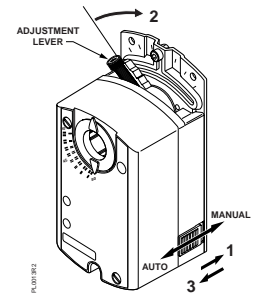

Figure 21.
Manual Override.

Mechanical Range Adjustment

To mechanically limit the range of the damper blade.

1. Loosen the stop set screw.
2. Move the screw along the track to the desired position, and fasten it in place.

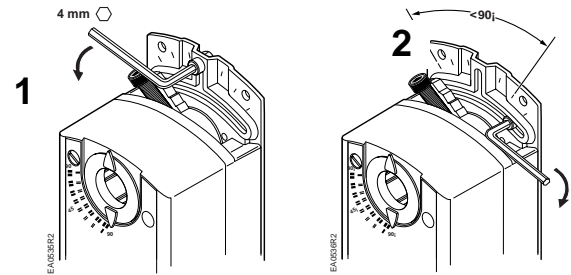

Figure 22. Moving the Mechanical Range Stop.

To use the entire 0 to 10V input signal to control the mechanically limited range, see Figure 17 for setting self-adaptive features.

Example:

Stop set screw at 70°
Self-adapt switch ON
Input signal Y = 5 Vdc

The damper will be at 35° (50% of the adjusted range.)

NOTE: On versions with the slope and offset features, this example assumes
Offset $U_0 = 0$ Vdc
Slope $\Delta U = 10$ Vdc

Wiring

- All wiring must conform to NEC and local codes and regulations.
- Use earth ground isolating step-down Class 2 transformers. Do not use autotransformers.
- The sum of the VA ratings of all actuators and all other components powered by one transformer must not exceed the rating of the transformer.
- It is recommended that one transformer power no more than 10 actuators.



WARNING:

All six outputs of the dual auxiliary switch (A and B) must only be connected to:

- Class 2 voltage (UL/CSA).
- Separated Extra-Low Voltage (SELV) or Protective Extra Low Voltage (PELV) (according to HD384-4-41) for installations requiring CE conformance.



WARNINGS:

Installations requiring CE Conformance:

- All wiring for CE certified actuators must be SELV or PELV rated per HD384-4-41.
- Use safety-isolating transformers (Class III transformer) per EN61558. They must be rated for 100% duty cycle.
- Over current protection for supply lines is maximum 10A.

Wiring Diagrams

Each wire has the standard symbol printed on it.

24 Vac power supply

0 to 10V modulating control

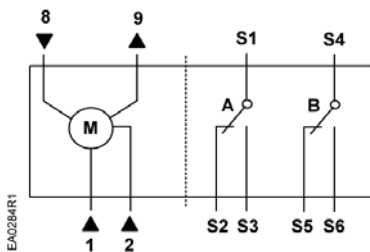

Table 4.

Standard Symbol	Function	Terminal Designation	Color
1	Supply (SP)	G	Red
2	Neutral (SN)	G0	Black
8	0 to 10V input signal	Y	Gray
9	Output for 0 to 10 Vdc position indication	U	Pink

Factory-installed Options

S1	Switch A Common	Q11	Black
S2	Switch A - NC	Q12	Black
S3	Switch A - NO	Q14	Black
S4	Switch B - Common	Q21	Black
S5	Switch B - NC	Q22	Black
S6	Switch B - NO	Q24	Black

Wiring , Continued

Terminal Strip

NOTE: Maximum wire size for the GDE161.1T is 14 AWG.

GDE161.1T

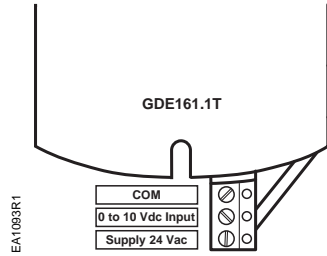

Figure 23. GDE161.1T Terminal Strip.

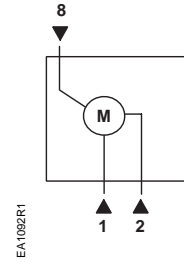

Figure 24. GDE161.1T Wiring Diagram.

Strain Relief

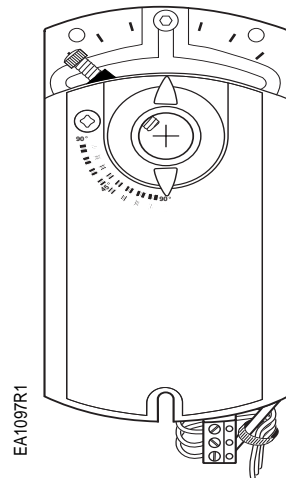

Figure 25.

Securing the wires/cabling will prevent breakage and ensure strong signals to and from the GDE161.1T model.

The following is recommended:

1. The open bracket to the right of the actuator terminal strip is the strain relief for the customer provided control wires.
2. Secure the wires to the actuator bracket with a cable tie as shown in Figure 25.

Wiring, Continued

Post Header AMP

GDE161.1N

The GDE161.1N Post Header AMP has two sets of identical contacts as shown in Figure 26.

- All wiring must conform to NEC and local codes and regulations.
- Use earth ground isolating step-down Class 2 transformers. Do not use autotransformers.

Determine the supply transformer rating by summing the total VA of all actuators used. It is recommended that one transformer power no more than 12 actuators.



WARNING:

Installations requiring CE Conformance

- All wiring for CE rated actuators must only be separated extra low voltage (SELV) or protective extra low voltage (PELV) per HD384-4-41.
- Use safety-isolating transformers (Class III transformer) per EN 61558. They must be rated for 100% duty cycle.
- Over current protection for supply lines is maximum 10A.



CAUTION:

It is necessary that the output current properly sustain and operate all GDE161.1N actuators in a daisy chain configuration.

NOTE:
 You must select either the top 3 contacts or the bottom 3 contacts.

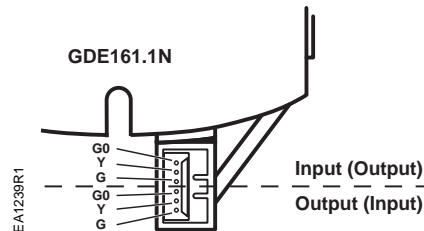

Figure 26. GDE161.1N Post Header AMP.

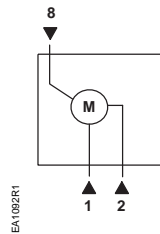

Figure 27. GDE161.1N 0 to 10 Vdc Modulating Control Wiring Diagram.

Wiring, Continued

Post Header AMP

The input cable (purchased separately) brings power and a control signal to the first actuator in a daisy chain configuration. See Figure 29 and Figure 30.



CAUTION:

Insert the plug into the GDE161.1N from the left to prevent damage to the cable wires. (See Figure 28)

1. The open bracket to the right of the actuator (See Figure 26) is used for strain relief of the customer purchased cabling (See *Required Tools*).
2. Secure the cabling to the actuator bracket with a cable tie. (See Figure 29.)

Modulating Control Input Cable	
985-133	3 ft
	12 pk

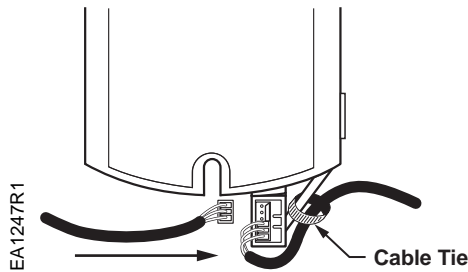

Figure 28. Always Insert the Cable From the Left.

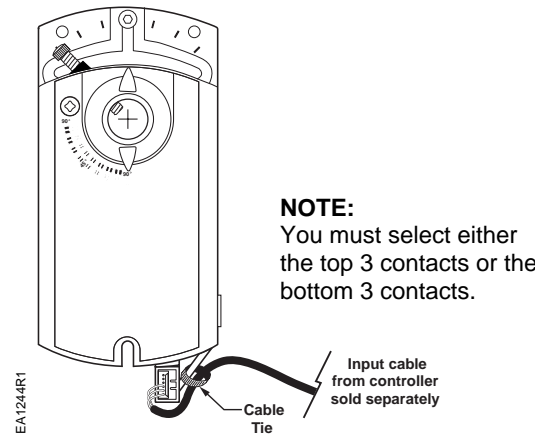

Figure 29. Input Cable Installed in Bottom Three Contacts.

Table 5.

Daisy Chain Cables	
985-134	12 ft
	12 pk
985-135	12 ft
	12 pk

Wiring, Continued

Daisy Chain Configuration,

NOTE:
You must select either the top 3 contacts or the bottom 3 contacts.

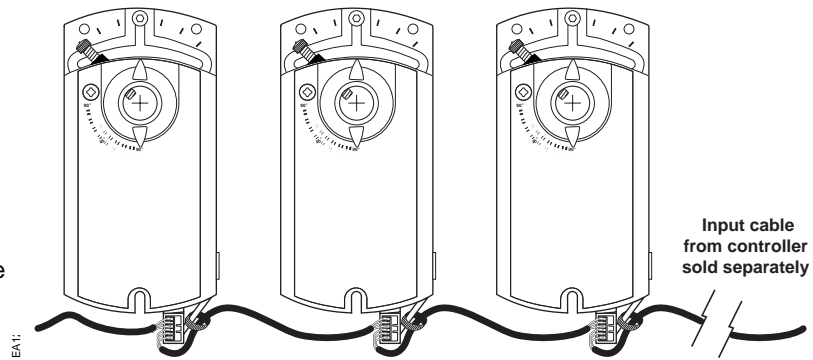

Figure 30.



WARNING:
Do not configure more than 12 actuators in a daisy chain at any time.

Troubleshooting



WARNING:
Do not open the actuator.
If the actuator is inoperative, replace the unit.

Start-Up/ Commissioning

1. Check that the wires are connected correctly.
 2. Check that offset and slope are set correctly, if used.
 3. Check that the direction of rotation switch/cable matches the rotation of the damper shaft.
 4. Connect wires 1 (red) and 2 (black) to a Digital Multimeter (DMM) with the dial set at AC V to verify that the operating voltage is within range.
-

Check operation:

1. Connect wires 1 (red) and 2 (black) to the actuator.
 2. Set the DMM dial to Vdc.
 3. Connect wires 2 (black) and 8 (gray) to the DMM.
 4. Apply a full-scale input signal (10 Vdc) to wire 8 (gray).
 5. Allow the actuator shaft coupling to rotate from 0 to 90°.
 6. Disconnect wire 8 (gray) and the shaft coupling returns to the "0" position.
-

Check Feedback:

1. Set the DMM dial to Vdc.
 2. Attach wires 2 (black) and 9 (pink) to the DMM.
 3. Apply a full-scale input signal to wire 8 (gray). The reading at the DMM should increase.
 4. Remove the signal from wire 8 (gray). The reading at the DMM should decrease and the actuator shaft coupling returns to the "0" position.
-

Check the Auxiliary Switch A:

1. Set the DMM dial to ohms (resistance) or continuity check.
2. Connect wires S1 and S3 to the DMM. The DMM should indicate open circuit or no resistance.
3. Apply a full-scale input signal to wire 8 (gray). The DMM should indicate contact closure as the actuator shaft coupling reaches the setting of switch A.
4. Connect wires S1 and S2 to the DMM. The DMM should indicate open circuit or no resistance.
5. Stop the signal to wire 8 (gray). The DMM should indicate contact closure as the actuator shaft coupling reaches the setting of switch A.

Check the Auxiliary Switch B:

1. Set the DMM dial to ohms (resistance) or continuity check.
 2. Connect wires S4 and S6 to the DMM. The DMM should indicate open circuit or no resistance.
 3. Apply a full-scale input signal to wire 8 (gray). The DMM should indicate contact closure as the actuator shaft coupling reaches the setting of switch B.
 4. Connect wires S4 and S5 to the DMM. The DMM should indicate open circuit or no resistance.
 5. Stop the signal to wire 8 (gray). The DMM should indicate contact closure as the actuator shaft coupling reaches the setting of switch B.
-

Dimensions

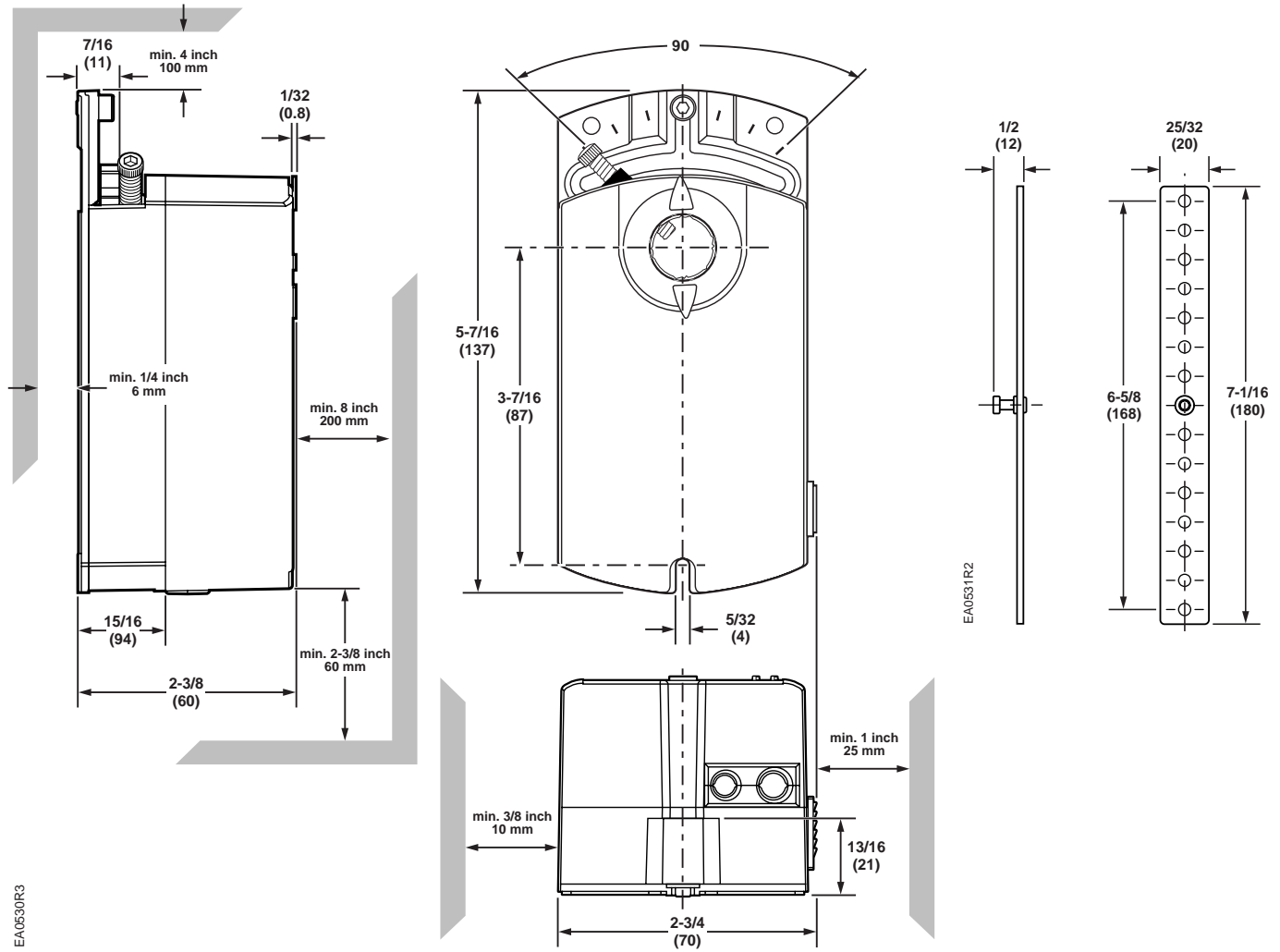

Figure 31. GDE/GLB Actuator and Mounting Bracket Dimensions in Inches (mm).

Dimensions, continued

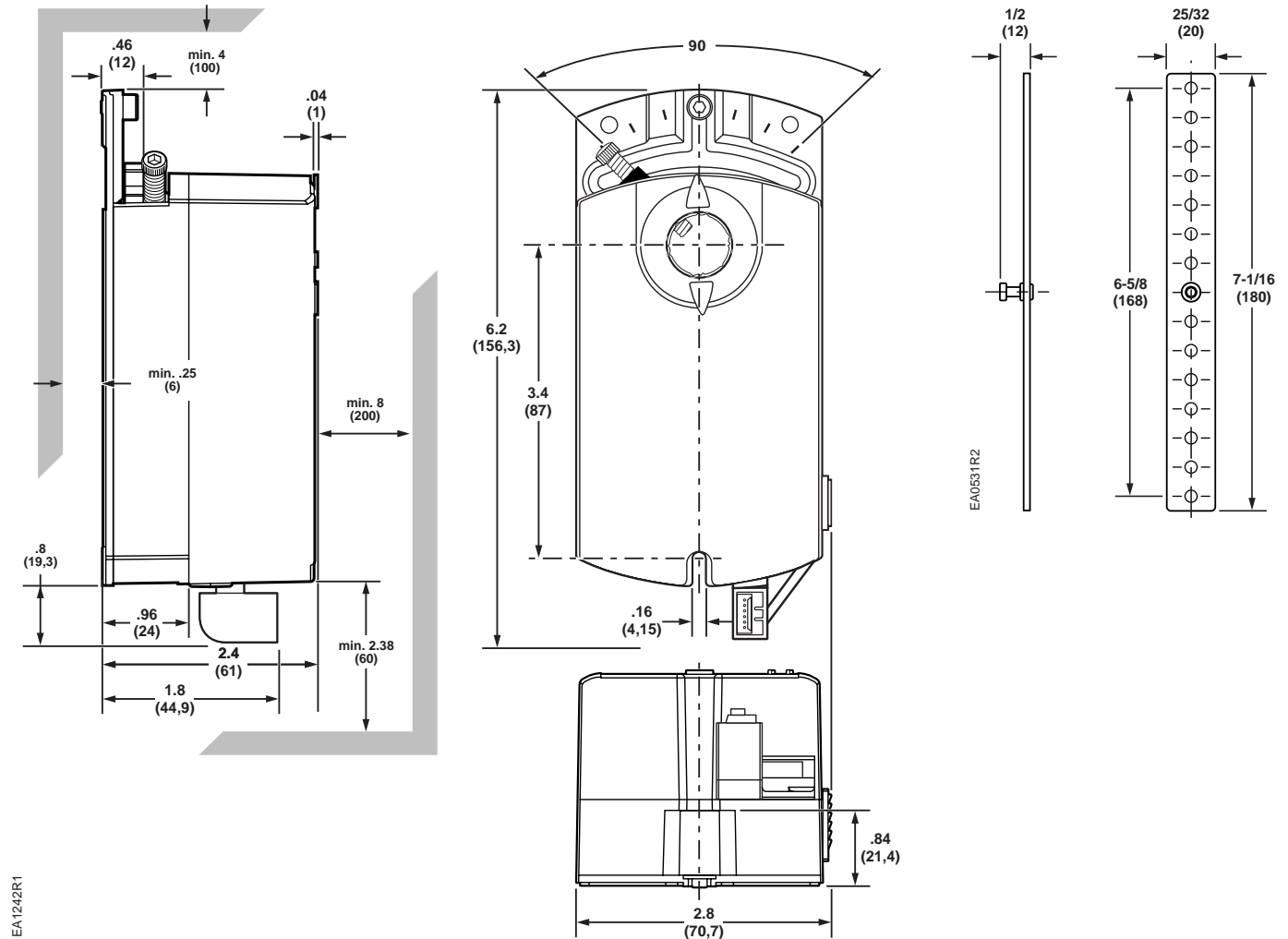

Figure 32. GDE161.1T and GDE161.1N Actuators and Mounting Bracket Dimensions in Inches (mm).

Information in this publication is based on current specifications. The company reserves the right to make changes in specifications and models as design improvements are introduced. OpenAir is a registered trademark of Siemens Schweiz AG. Other product or company names mentioned herein may be the trademarks of their respective owners. © 2011 Siemens Industry, Inc.